

COLLECTIVE AND SINGLE-PARTICLE STRUCTURES IN NEUTRON-RICH
NUCLEI

J. H. HAMILTON^a, S. J. ZHU^{a,b,c}, Y. X. LUO^{a,c,d}, J. K. HWANG^a,
A. V. RAMAYYA^a, P. M. GORE, J. O. RASMUSSEN^c and GANDS collaborations

^a*Physics Department, Vanderbilt University, Nashville, TN 37235, U. S. A.*

^b*Department of Physics, Tsinghua University, Beijing 100084, China*

^c*Joint Institute for Heavy Ion Research, Oak Ridge, TN 37830, U. S. A.*

^d*Lawrence Berkeley National Laboratory, Berkeley, CA 94720, U. S. A.*

Paper devoted to honour the memory of Professor Nikola Cindro

Received 14 March 2002; revised manuscript received 26 February 2003

Accepted 10 March 2003 Online 3 March 2004

The neutron-rich nuclei of $^{104,106}\text{Mo}$, $^{139,141}\text{Ba}$, ^{139}Xe , $^{115,117}\text{Ag}$ and $^{133,135}\text{Te}$ have been studied by using the spontaneous fission source of ^{252}Cf with the Gamma-sphere array. In the present work, the collective and single particle structures in these neutron-rich nuclei have been reported. Gamma type vibrational bands in $^{104,106}\text{Mo}$, particle and hole states, including candidates for tilted rotor bands in $^{133,135}\text{Te}$ and a $7/2[413]$ rotational band in both $^{115,117}\text{Ag}$ have been observed. The $N = 83$ ^{135}Te and ^{139}Ba show marked differences associated with differences in their particle and hole states. New levels in ^{141}Ba and ^{139}Xe extend evidence for two opposite parity doublets characteristic of stable octupole deformation.

PACS numbers: 21.10.-k, 27.60.+j, 25.85.Ca, 21.60.Cs

UDC 539.165

Keywords: neutron-rich nuclei, fission, tilted rotor bands, particle-hole states

1. Introduction

The extensive new information on the structures of neutron-rich nuclei populated in spontaneous fission (SF) from small detector arrays and the first studies with Gammasphere and Eurogam were reviewed in 1995 [1]. In the next five years, additional significant insights have been found (see for example Ref. [2]). In the year 2000, we carried out $\gamma - \gamma - \gamma$ coincidence studies in the spontaneous fission of ^{252}Cf using 102 detectors in Gammasphere and acquired numbers of events that

were significantly larger than that in our three-week run of 1995. These data opened up the opportunity to study nuclei populated to higher spin states in known bands and new side bands and to assign γ -rays to previously unidentified nuclei. In this paper we present a few selected examples of the new physics to come from such higher statistical data. The one- and two-phonon γ vibrational bands in $^{104,106}\text{Mo}$ have been significantly expanded and have been found to have reasonably similar transition energies. New particle and hole states are found in $^{133,135}\text{Te}$. The first example of tilted rotor bands in neutron-rich nuclei are reported in these nuclei. The $N = 83$ ^{135}Te and ^{139}Ba have a different energy level pattern related to the presence of particle states in ^{135}Te and hole states in ^{139}Ba . New levels of ^{139}Xe and ^{141}Ba extend our insight into the stable octupole configuration in this region.

2. *Experimental procedure*

In the present work, the measurements were carried out at the Lawrence Berkeley National Laboratory by using a spontaneous fission ^{252}Cf source inside Gammasphere. This ^{252}Cf source of about 62 μCi was sandwiched between two Fe foils of thickness 10 mg/cm² and was mounted in a 7.62 cm diameter plastic (CH) ball to absorb β rays and conversion electrons. The source was placed at the center of the Gammasphere array which, for this experiment, consisted of 102 Compton suppressed Ge detectors. A total of 5.7×10^{11} triple and higher-fold coincidence events were collected. The coincidence data were analyzed with the RADWARE software package [3]. The width of the coincidence time window was about 1 μs .

3. *Structures of neutron-rich nuclei*

3.1. *Gamma vibrational bands in $^{104,106}\text{Mo}$*

With our new much higher statistical data, we have extended the gamma vibrational bands from 3 to 10 higher spin states in $^{104,106}\text{Mo}$, as shown in Figs. 1 [4] and 2 [5]. The γ -bands in both $^{104,106}\text{Mo}$ exhibit odd-even spin staggering up to 13^+ and 14^+ to suggest their shapes are triaxial. Bands beginning at 1583.4 and 1434.9 keV in $^{104,106}\text{Mo}$ are proposed as two gamma phonon bands [4,5]. We have extended these bands from 8^+ to 11^+ . The transition energies are strikingly close in every case for the same spin ($11^+ \rightarrow 9^+$, $9^+ \rightarrow 7^+$, etc.) transitions in the one- and two-phonon gamma bands (see bands 2 and 3 in Figs. 1 and 2).

The J_1/J_{rigid} ratios for ^{104}Mo are 0.92 for band (4) and 0.87 for band (6), as shown in Fig. 3. The J_1/J_{rigid} ratios are 0.88 for band (4), 0.86 for band (5), 0.84 for band (7) and 0.87 for band (8), as shown in Fig. 4. The results indicate that quasiparticle bands in $^{104,106}\text{Mo}$ as well as in ^{102}Zr may belong to the pairing-free bands as observed in ^{98}Y , ^{102}Nb [6] and ^{145}Ba [7]. The origin of these pair-free bands in ^{104}Mo and ^{102}Zr is not clear, but definitely offers a new challenge to theory.

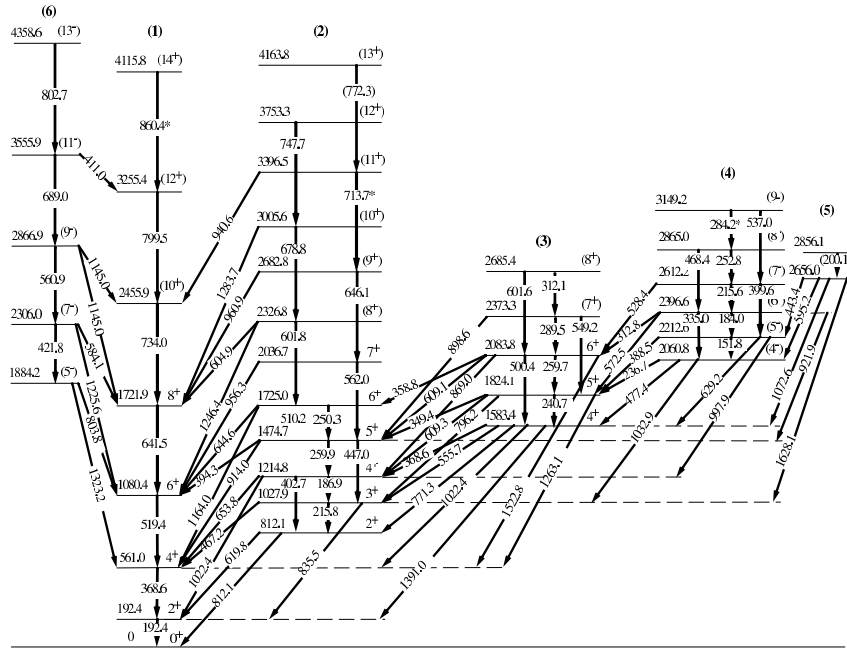

$^{104}_{42}\text{Mo}_{62}$

Fig. 1. Level scheme of ^{104}Mo . * indicates found in this work.

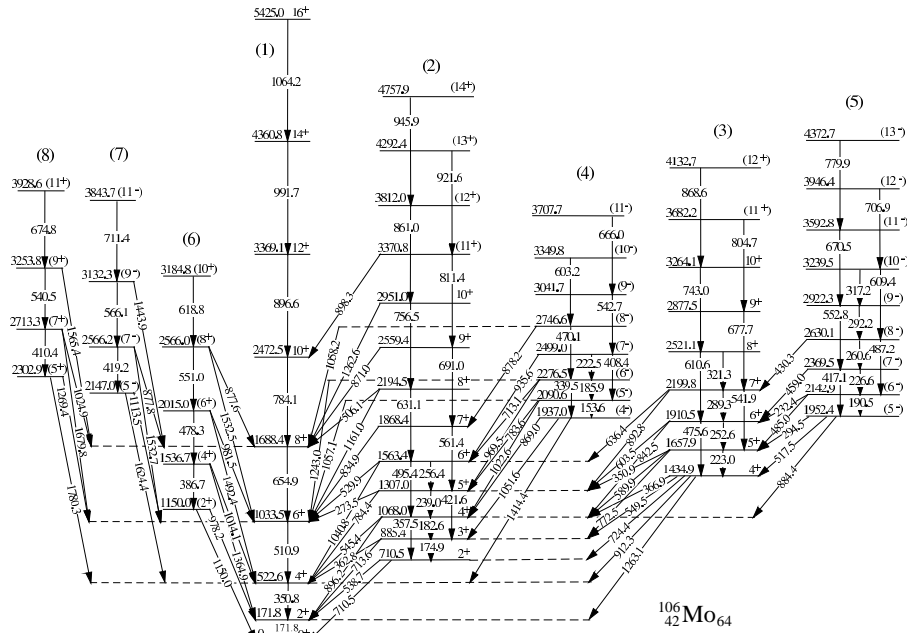

$^{106}_{42}\text{Mo}_{64}$

Fig. 2. Level scheme of ^{106}Mo .

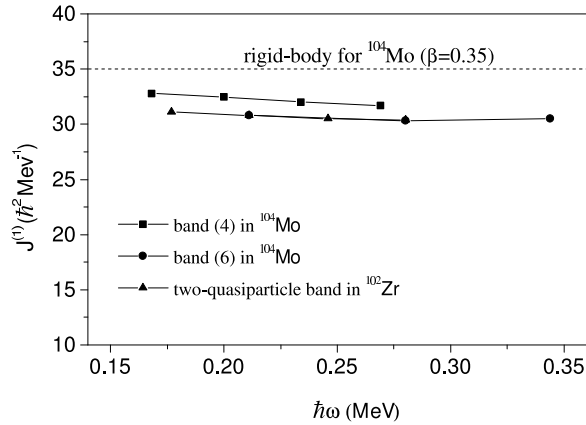

Fig. 3. The J_1 values for ^{104}Mo .

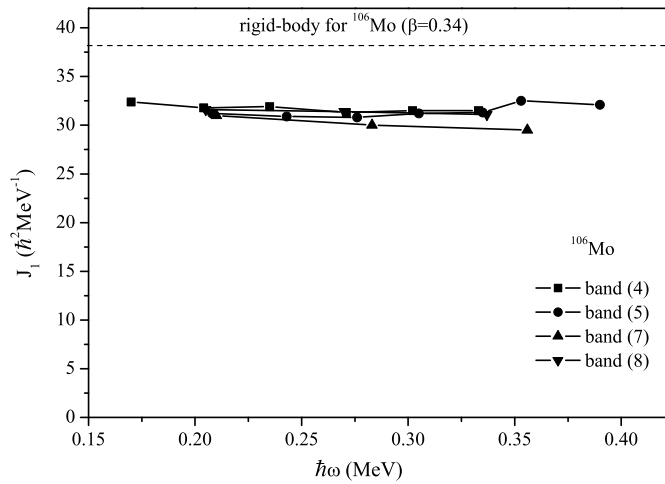

Fig. 4. The J_1 values for ^{106}Mo .

3.2. Particle and hole states in $^{133,135}\text{Te}$ and ^{139}Ba

The high-spin levels in $^{133,135}\text{Te}$ and ^{139}Ba have recently been independently extended, as shown in Figs. 5 – 7 [8,9]. These data provide new tests of particle-hole structures around the double magic ^{132}Sn , as described in Refs. [8,9]. Particle and hole states are identified and extended in $^{133,135}\text{Te}$. Groups of states beginning at 4.023 MeV for ^{135}Te and 5.214 MeV for ^{133}Te , related to the neutron particle-hole excitation of the double magic core nucleus ^{132}Sn , provide possible candidates for tilted rotor bands. Near the lower end of the band, the neutron total angular momentum can couple at near right angles to the proton angular momentum vec-

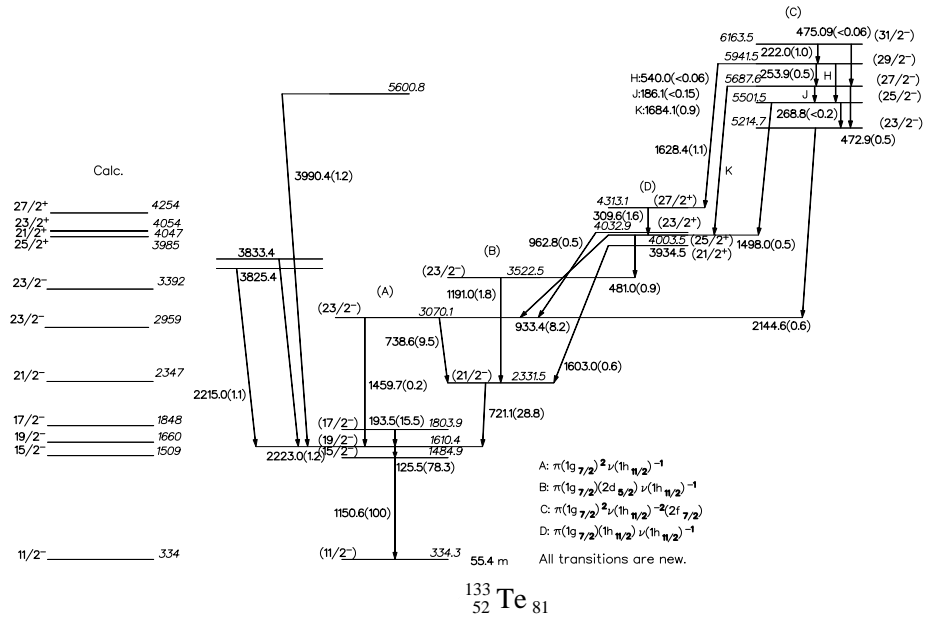

Fig. 5. Level scheme of ¹³³Te.

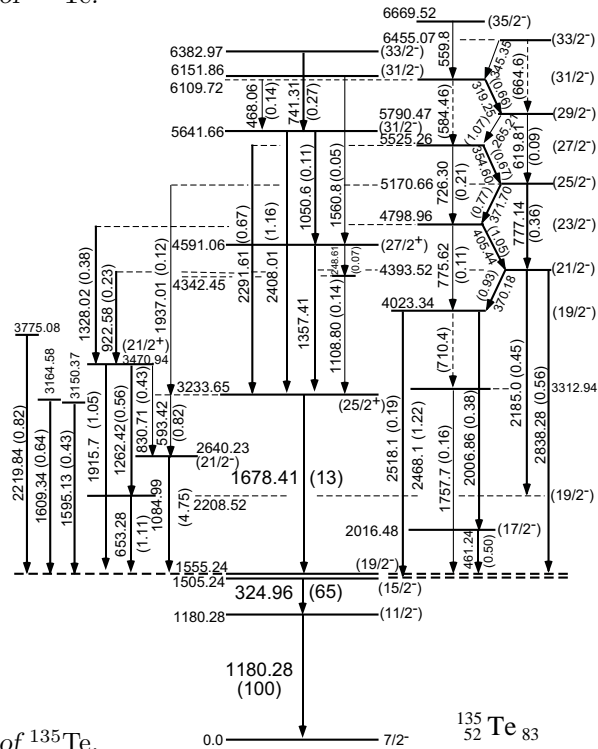

Fig. 6. Level scheme of ¹³⁵Te.

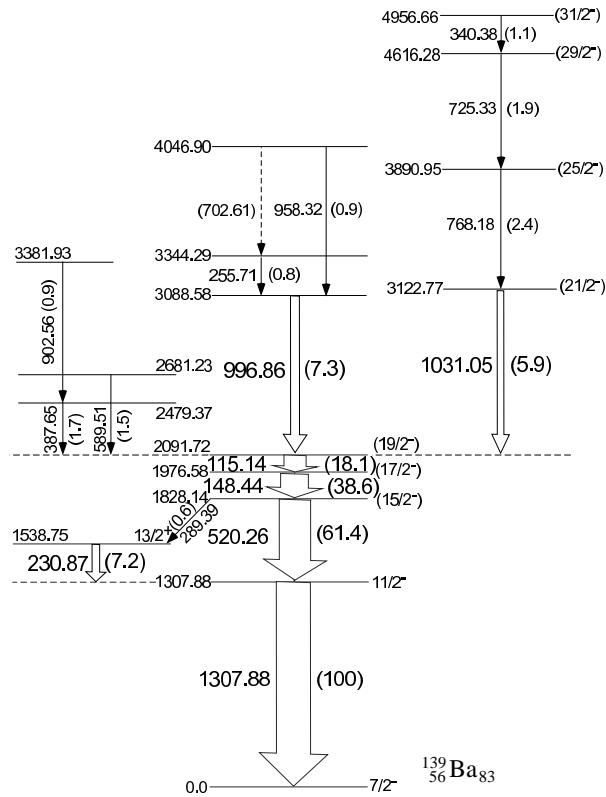

Fig. 7. Level scheme of ^{139}Ba .

tor. Such tilted rotor bands are characterized by strong M1 cascade transitions with weak crossovers as seen in this band. We would expect on geometrical grounds that fission fragments would prefer populating some kind of prolate bands as intermediates on the path to spherical ground states. Fornal et al. [10] assigned the band beginning at 4.023 MeV as the promotion of an $h_{11/2}$ neutron across the 82 shell gap to pair up with the $f_{7/2}$ neutron. For a prolate deformed potential, the two protons would be in the $1/2[431]$ orbital and the neutrons would have a pair in the $1/2[541]$ and a hole in the $11/2[505]$. These are the first proposals for tilted rotor bands in neutron-rich nuclei and for prolate-spherical shape coexistence in nuclei around the double magic ^{132}Sn . The $N = 83$ ^{135}Te and ^{139}Ba show marked differences associated with differences in their band structures related to ^{135}Te having particle states and ^{139}Ba hole states. In particular, note the change at low excitations in the band structure in ^{135}Te and ^{139}Ba : in ^{139}Ba , an extra $17/2^-$ level is seen below the $19/2^-$ one. The theoretical shell model calculations using relativistic effective interaction derived from the CD-born nucleon-nucleon potential are in good agreement with the experimental data for the excitation energy levels up to 4.3 MeV for ^{133}Te .

3.3. Octupole collectivity in ^{141}Ba and ^{139}Xe

Our new level schemes for $N = 85$ ^{141}Ba and ^{139}Xe are shown in Figs. 8 and 9 [11]. We observe five bands, and propose spins and parities. The two positive parity bands extend to the highest excitation energies and spins among all $N = 85$ isotones. Bands 2 – 3 are extended from our earlier work [12], and their parity assignments were inverted. Bands 1 and 2 may be predominantly based on the neutron $(f_{7/2})^3$ and $(f_{7/2})^2h_{9/2}$ configurations. In analogy with the higher Z $N = 85$ isotones, it seems logical to assign band 3 as the odd $f_{7/2}$ neutron stretch-coupled to an octupole phonon. Band 4, likewise, fits the isotone systematics of the odd $f_{7/2}$ neutron stretch-coupled to two octupole phonons. Band 5 may result from the coupling of an octupole phonon to band 2. The structure of ^{141}Ba appears to be intermediate between the spherical shell-model type observed in ^{139}Ba and the stable octupole shapes found in heavier Ba isotopes.

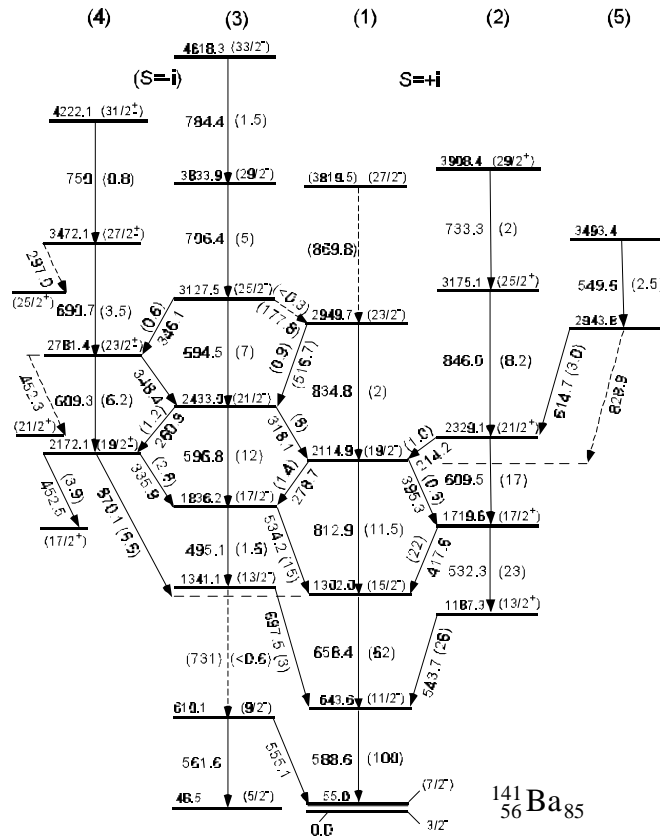

Fig. 8. Level scheme of ^{141}Ba .

Level systematics and analogies of decay patterns for the $N = 85$ even-odd isotones support the spin and parity assignments. Lower-lying excited states in ^{141}Ba

and ^{139}Xe are interpreted in the spherical shell model as valence-neutron particle excitations, or as octupole excitations coupled with the single neutron states. However, quadrupole and octupole collectivity, showing up in the developed bands, limits the applications of the simple shell model in these nuclei and makes it likely that there is increasing participation of the valence protons in contributing angular momentum at higher spins. The level spacings of the observed bands in ^{141}Ba and ^{139}Xe become somewhat regular in comparison with those of isotones near the $Z = 64$ subshell, and this comparative regularity is seen when the yrast bands of ^{141}Ba and ^{139}Xe are compared with those of their neighboring even-even isotopes ^{140}Ba and ^{138}Xe , respectively. This suggests that the collective motions, primarily quadrupole rotation/vibrations, have come into play in ^{141}Ba and ^{139}Xe . The increasing excitation energies of the $13/2^+$ states and the decreasing relative intensities of the positive parity bands of the $N = 85$ even-odd isotones with decreasing proton number of the isotones may be an indication that when approaching the $Z = 50$ proton shell, the octupole excitations of the $N = 85$ even-odd isotones require more energy, and finally go above the yrast line and are not observable in the prompt-fission gamma spectra.

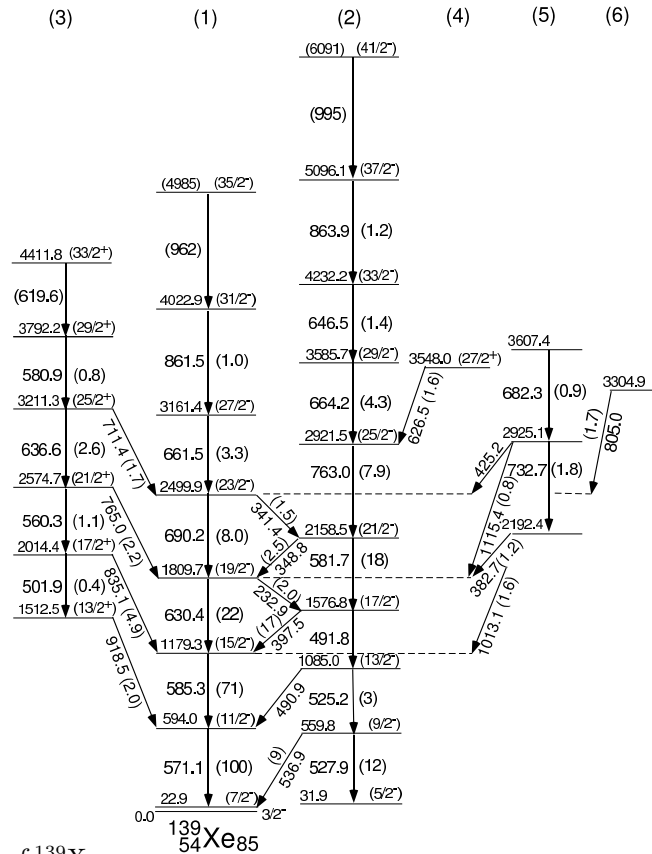

Fig. 9. Level scheme of ^{139}Xe .

3.4. Band structures in $^{115,117}\text{Ag}$

The new level schemes of $^{115,117}\text{Ag}$ were built from the SF work with ^{252}Cf , as shown in Figs. 10 and 11 [13]. Earlier studies of odd-Ag isotopes were carried out from the β -decay work on Pd isotopes [14]. Excited bands with $K^\pi=1/2^+$ built on the proton $1/2^+[431]$ intruder orbital have been observed in odd mass $^{105-115}\text{Ag}$ and odd mass indium nuclei along with other low-spin states in ^{115}Ag [14]. The excitation energy of the intruder bands is a minimum in ^{113}Ag with $N = 66$. The complicated bands discovered from the β -decay [14] in odd-A In isotopes have been explained by coupling a hole to their Sn cores and a particle to their Cd cores. These kinds of bands were not observed in the adjacent odd-mass Ag isotopes which were also studied in β decay [14]. Isomeric states with spin and parity of $7/2^+$ were observed in $^{115,117}\text{Ag}$ [14]. The Ag isotopes are partners of Sb in the spontaneous fission (SF) of ^{252}Cf . We have used this relation to identify the levels in $^{115,117}\text{Ag}$. A $7/2[413]$ rotational band is identified in both $^{115,117}\text{Ag}$. High-spin states observed in $^{115,117}\text{Ag}$ are interpreted by using the Nilsson deformed shell model, since the rotational band spacings are sufficiently small. We recognize that these Ag nuclei may be in a region of shape coexistence, where the spherical shell model with phonons may be a more appropriate basis for some states and the deformed (Nilsson) shell model for others, especially for the yrast and near-yrast levels populated in these fission experiments.

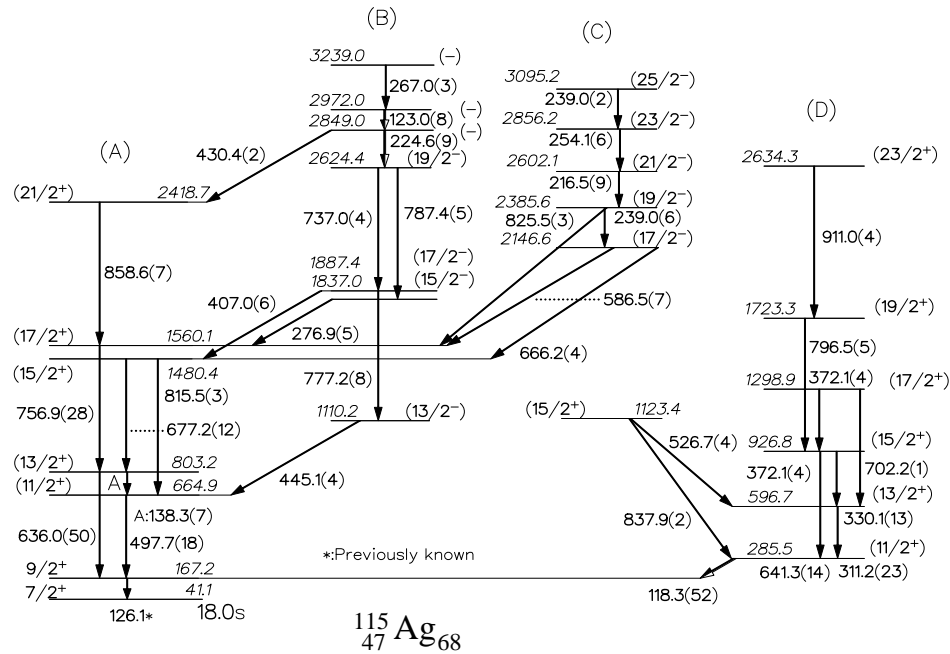

Fig. 10. Level scheme of ^{115}Ag .

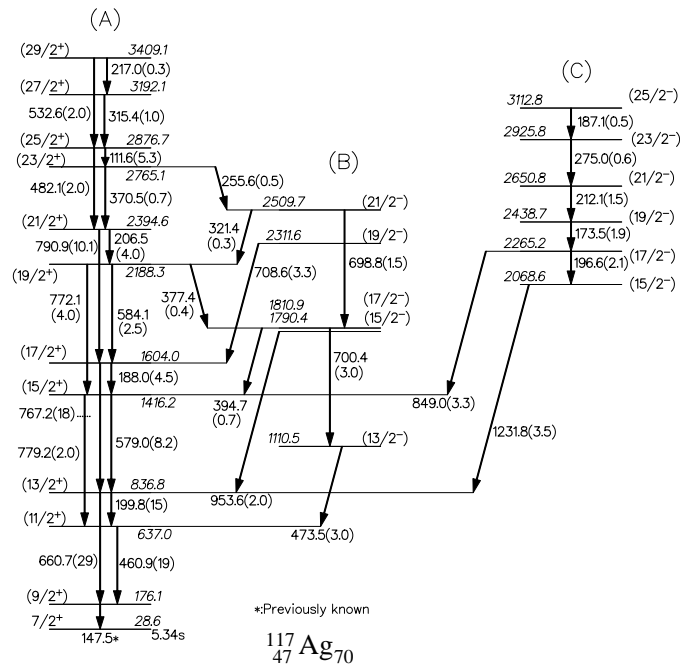

Fig. 11. Level scheme of ${}^{117}\text{Ag}$.

4. Conclusions

The neutron-rich nuclei of ${}^{104,106}\text{Mo}$, ${}^{139,141}\text{Ba}$, ${}^{139}\text{Xe}$, ${}^{115,117}\text{Ag}$ and ${}^{133,135}\text{Te}$ have been studied by using a spontaneous fission (SF) source of ${}^{252}\text{Cf}$ with the Gammasphere array. With new high-statistic data, new isotopes and new high-spin structures have been observed in neutron-rich nuclei populated in the spontaneous fission of ${}^{252}\text{Cf}$. Gamma type vibrational bands are seen up to 13^+ in ${}^{104}\text{Mo}$ and 14^+ in ${}^{106}\text{Mo}$. Particle and hole states are identified and extended in ${}^{133,135}\text{Te}$. Groups of states in each nuclei related to a neutron particle-hole excitation of the double-magic core nucleus ${}^{132}\text{Sn}$ provide possible candidates for tilted rotor bands. The $N = 83$ ${}^{135}\text{Te}$ and ${}^{139}\text{Ba}$ show marked differences associated with differences in their particle and hole states. New levels in ${}^{141}\text{Ba}$ and ${}^{139}\text{Xe}$ extend evidence for two opposite parity doublets characteristic of stable octupole deformation. A $7/2[413]$ rotational band is identified in both ${}^{115,117}\text{Ag}$.

Acknowledgements

The work at Vanderbilt University is supported by the U.S. Department of Energy under Grant No. DE-FG05-88ER40407. The Joint Institute for Heavy Ion Research is supported by the University of Tennessee, Vanderbilt University and the U.S. DOE.

References

- [1] J. H. Hamilton, A. V. Ramayya, S. J. Zhu, G. M. Ter-Akopian, Yu. Ts. Oganessian, J. D. Cole, J. O. Rasmussen and M. A. Stoyer, *Prog. in Part. and Nucl. Phys.* **35** (1995) 635.
- [2] J. H. Hamilton et al., *Proc. 3rd Int. Conf. Exotic Nuclei and Atomic Masses*, Finland (2001).
- [3] D. C. Radford, *Nucl. Instrum. Methods Phys. Res. A* **361** (1995) 297.
- [4] L. M. Yang et al., *Chinese Phys. Lett.* **18** (2001) 24 (in chinese).
- [5] R. Q. Zhu et al., *Chinese Phys. Lett.* **19** (2002) 180 (in chinese).
- [6] J. K. Hwang et al., *Phys. Rev. C* **58** (1998) 3252.
- [7] S. J. Zhu et al., *Phys. Rev. C* **60** (1999) 051304.
- [8] J. K. Hwang, A. V. Ramayya, J. H. Hamilton, C. J. Beyer, J. O. Rasmussen, Y. X. Luo, S. C. Wu, T. N. Ginter, C. M. Folden III, P. Fallon, P. M. Zielinski, K. E. Gregorich, A. O. Macchiavelli, M. Stoyer, S. J. Asztalos, A. Covello and A. Gargano, *Phys. Rev. C* **65** (2002) 034319.
- [9] L. X. Luo et al., *Phys. Rev. C* **64** (2001) 054306.
- [10] B. Fornal, R. Broda, P. J. Daly, P. Bhattacharyya, C. T. Zhang, Z. W. Grabowski, I. Ahmad, D. Seweryniak, I. Wiedenhover, M. P. Carpenter, R. V. F. Janssens, T. L. Khoo, T. Lauritsen, C.J. Lister and P. Reiter, *Phys. Rev. C* **63** (2001) 024322.
- [11] Y. X. Luo et al., *Phys. Rev. C* **66** (2002) 014305.
- [12] S. J. Zhu et al., *J. Phys. G* **23** (1997) L77.
- [13] J. K. Hwang et al., *Phys. Rev. C* **65** (2002) 054314.
- [14] *Table of Isotopes*, 8th edition, eds. R. B. Firestone et al., Wiley, New York (1996).

Recommendation: Several figures in this article have many details written with small alphanumeric characters. They could not be reproduced well on the printed page even if turned by 90°. If the reader is interested in details, the Editor suggests reading enlarged files on the Fizika home pages (<http://fizika.hfd.hr>).

KOLEKTIVNE I JEDNOČESTIČNE STRUKTURE U JEZGRAMA BOGATIM NEUTRONIMA

Proučavali smo neutronima bogate jezgre $^{104,106}\text{Mo}$, $^{139,141}\text{Ba}$, ^{139}Xe , $^{115,117}\text{Ag}$ i $^{133,135}\text{Te}$ pomoću izvora spontane fisije ^{252}Cf , primjenom uređaja Gammasphere. Prikazujemo njihove kolektivne i jednočestične strukture. Opazili smo γ -vibracijske vrpce u $^{104,106}\text{Mo}$, čestična i šupljinska stanja, uključivši kandidate za nagnutu rotorsku vrpcu u $^{133,135}\text{Te}$ i rotacijsku vrpcu $7/2[413]$ u $^{115,117}\text{Ag}$. Jezgre ^{135}Te i ^{139}Ba s $N = 83$ su izrazito različite zbog razlika u njihovim čestičnim i šupljinskim stanjima. Novi nivoi jezgara ^{141}Ba i ^{139}Xe daju dodatni dokaz za postojanje dvaju dubleta suprotne parnosti koji su karakteristični za stabilnu oktopolnu deformaciju.